

PRODUCT



DESCRIPTION

- Opening angle: 107° / 100°
- Cabinet width up to 1800mm
- Cabinet height: 250-700mm
- Door thickness: 16-28mm
- 3D door adjustments:
Height adjustment: +/-2mm,
Depth adjustment: +/-2mm,
Side adjustment: +/-2mm,
- Easy to open, and stays at any desired position
- Adjustable soft-closing speed
- Adjustable opening and hovering forces
- Tool free assembly and removal
- Single and dual-colour caps at your disposal

Power factor LF=

Cabinet height KH(mm) x door weight incl. double handle weight(kg)

Note: The power factor LF and the door weight can be increased by 50% when a third lift mechanism is used.

ORDER INFORMATION

1		Lift Mechanism set/ Industrial Package			
	Power Factor LF	Dynamic	Opening angle	Item No.	Set/ctn
	480-1500	Extra Light	107°	SF00AD	10
	750-2500	Light	107°	SF00AL	10
	1500-4900	Medium	107°	SF00AM	10
	3200-9000	Strong	100°	SF00AH	10
3		Front Fixing-brackets set/Industrial Package For Wooden Door and Wide Alu Frames			
		Nickel Plated			
	Item No.	SF00YQ			
	Set/ctn	200			
5		Single Caps(left/right) / Industrial Package			
	Colour	Item No.	Set/ctn		
	White	SFJS02A	20		
	Grey	SFJS02B	20		

2		Opening angle restriction clip / Industrial Package Plastic		
	100°	Dark grey(H11)		
		Opening angle	Item No.	Pcs/ctn
	100°	SFW100	1000	
	75°	SFW75	1000	
4		Narrow Alu Frame fixing-brackets set Industrial Package For Narrow Alu Frames		
		Nickel Plated(A01)		
	Item No.	SF00H		
	Set/ctn	100		
		16 pcs Φ3,5X8,5mm countersunk screws included		
6		Dual-colour Caps(left/right) / Industrial Package		
	Colour	Item No.	Set/ctn	
	White+ light grey	SFJS01A	20	
	Grey+ dark grey	SFJS01B	20	
	White+ nickel plated	SFJS01C	20	
	Grey+ nickel plated	SFJS01D	20	

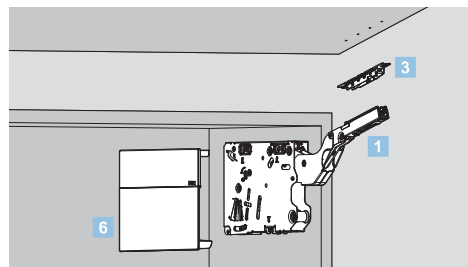
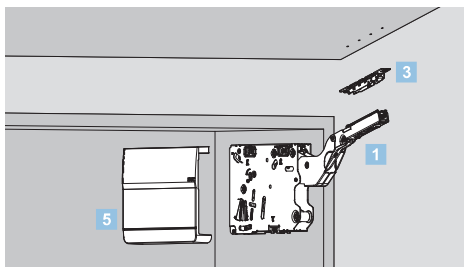

ORDER INFORMATION

T1 Recommended Kit Package

Including:

1x lift mechanism set, 1x white single caps set, 1x front fixing-brackets set, 10x wooden screws Ø4X35mm, 8x wooden screws Ø4X16mm, 8x countersunk screws

Please select the corresponding kit package item No. according to power factor and cabinet height

Power Factor(LF)	Cabinet Height	Kit package item No.
480-1500	250-500mm	SF00AD02A
750-2500	250-500mm	SF00AL02A
1500-4900	350-500mm	SF00AM02A
3200-9000	400-700mm	SF00AH02A

T2 Recommended Kit Package

Including:

1x lift mechanism set, 1x grey single caps set, 1x front fixing-brackets set, 10x wooden screws Ø4X35mm, 8x wooden screws Ø4X16mm, 8x countersunk screws

Please select the corresponding kit package item No. according to power factor and cabinet height

Power Factor(LF)	Cabinet Height	Kit package item No.
480-1500	250-500mm	SF00AD02B
750-2500	250-500mm	SF00AL02B
1500-4900	350-500mm	SF00AM02B
3200-9000	400-700mm	SF00AH02B

T3 Recommended Kit Package

Including:

1x lift mechanism set, 1x white+light grey dual-colour caps set, 1x front fixing-brackets set, 10x wooden screws Ø4X35mm, 8x wooden screws Ø4X16mm, 8x countersunk screws

Please select the corresponding kit package item No. according to power factor and cabinet height

Power Factor(LF)	Cabinet Height	Kit package item No.
480-1500	250-500mm	SF00AD01A
750-2500	250-500mm	SF00AL01A
1500-4900	350-500mm	SF00AM01A
3200-9000	400-700mm	SF00AH01A

T4 Recommended Kit Package

Including:

1x lift mechanism set, 1x grey+dark grey dual-colour caps set, 1x front fixing-brackets set, 10x wooden screws Ø4X35mm, 8x wooden screws Ø4X16mm, 8x countersunk screws

Please select the corresponding kit package item No. according to power factor and cabinet height

Power Factor(LF)	Cabinet Height	Kit package item No.
480-1500	250-500mm	SF00AD01B
750-2500	250-500mm	SF00AL01B
1500-4900	350-500mm	SF00AM01B
3200-9000	400-700mm	SF00AH01B

T5 Recommended Kit Package

Including:

1x lift mechanism set, 1x white+nickel plated dual-colour caps set, 1x front fixing-brackets set, 10x wooden screws Ø4X35mm, 8x wooden screws Ø4X16mm, 8x countersunk screws

Please select the corresponding kit package item No. according to power factor and cabinet height

Power Factor(LF)	Cabinet Height	Kit package item No.
480-1500	250-500mm	SF00AD01C
750-2500	250-500mm	SF00AL01C
1500-4900	350-500mm	SF00AM01C
3200-9000	400-700mm	SF00AH01C

T6 Recommended Kit Package

Including:

1x lift mechanism set, 1x grey+nickel plated dual-colour caps set, 1x front fixing-brackets set, 10x wooden screws Ø4X35mm, 8x wooden screws Ø4X16mm, 8x countersunk screws

Please select the corresponding kit package item No. according to power factor and cabinet height

Power Factor(LF)	Cabinet Height	Kit package item No.
480-1500	250-500mm	SF00AD01D
750-2500	250-500mm	SF00AL01D
1500-4900	350-500mm	SF00AM01D
3200-9000	400-700mm	SF00AH01D

In the case of narrow alu frame application, order fixing-brackets SF00H separately.

TOP-STAYS

SF Series Lifting System

TOP-STAYS

Assembly, Removal and Adjustment (for SF series Lifting System)

PLANNING

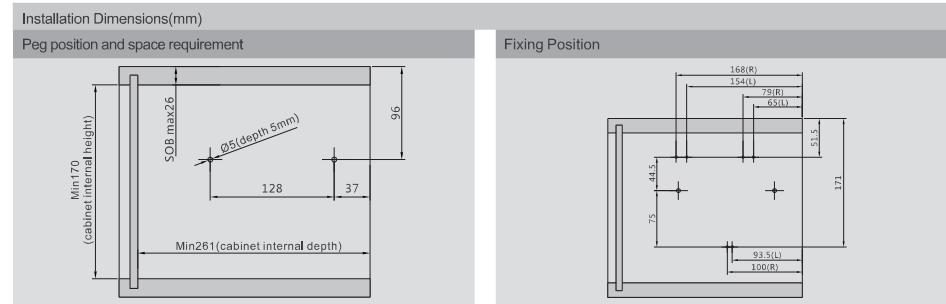

SOB: top panel thickness

3x wooden screws Ø4X35mm

Door planning and assembly- wooden doors and wide alu frames

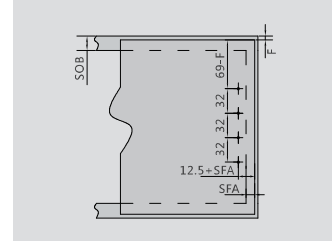

8 wooden screws for wooden doors (Ø4X16mm)
8 countersunk screws for wide alu frames (M4X11mm)
SFA: door overlay on the side panel
F: gap

Door planning and assembly- narrow alu frames

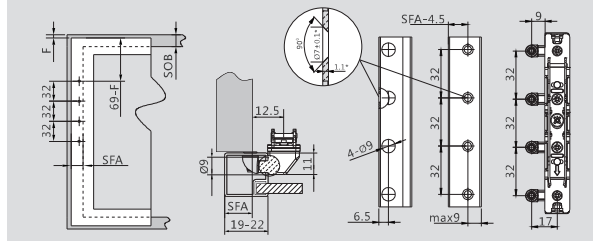

Frame width(mm)	19	20	21	22
SFA(mm)	15~19	16~20	17~21	18~22

16 countersunk screws for narrow alu frames (Φ3.5X8.5mm)
*When changing material thickness, adjust the assembly dimensions accordingly

Cornice/crown moulding clearance

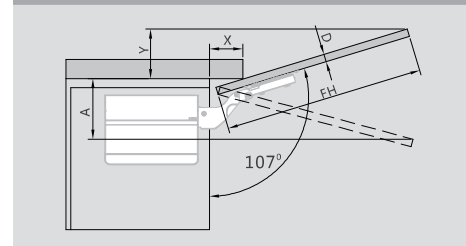

D(mm)	16	19	22	26	28
X(mm)	70	58	49	35	26
Opening angle restriction	Space requirement (mm)				
without	Y=FH x 0.29-15+D				
100°	Y=FH x 0.17-15+D				
75°	A=FH x 0.26+15-D				

Minimum gap

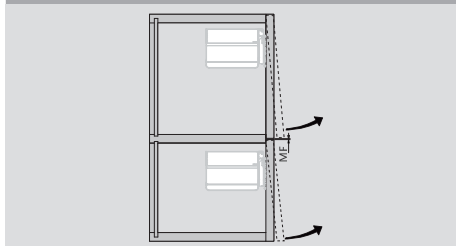

MF: Minimum gap 2mm

Assembly

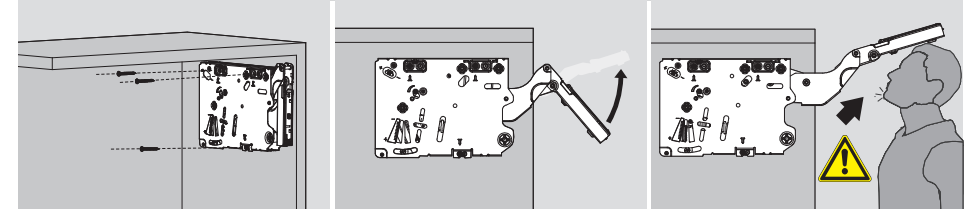

Assembly

Caution when opening arm

The arm of this device could spring up and cause injury. Do not push the arm down without door attached.

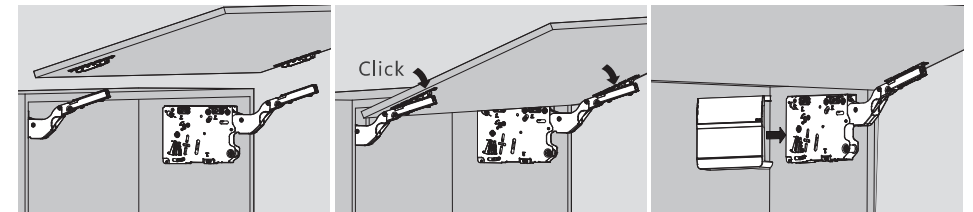

Door Assembly

Hovering Adjustment

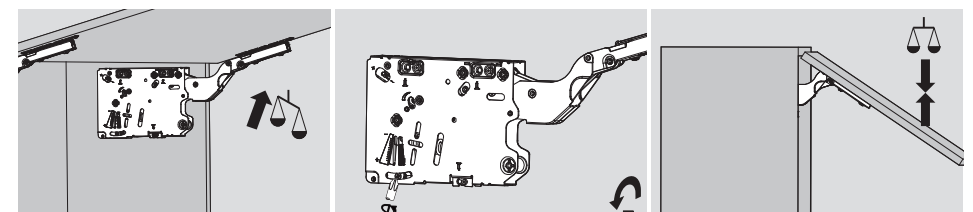
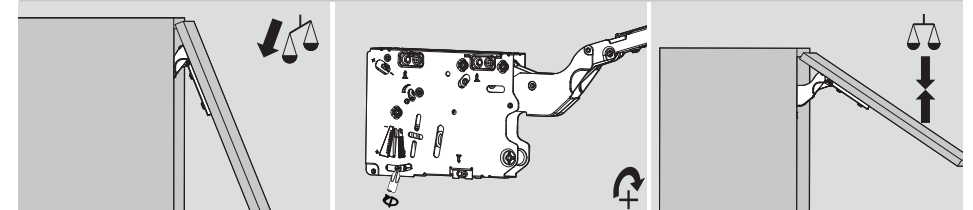

TOP-STAYS

Assembly , Removal and Adjustment(for SF series Lifting System)

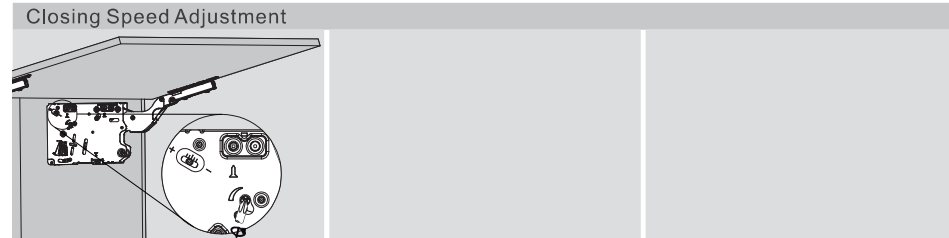

"+" increasing soft-closing time (turn adjustment screw counter-clockwise)
"- " reducing soft-closing time (turn adjustment screw clockwise)

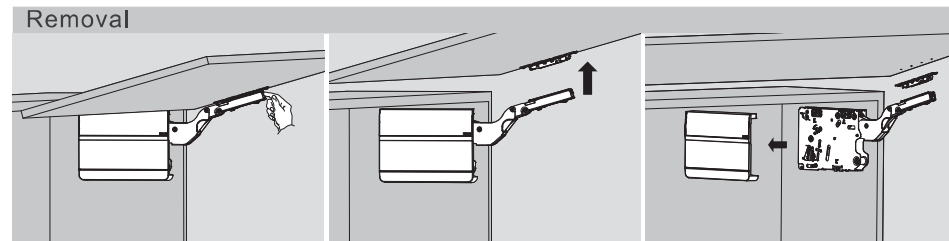
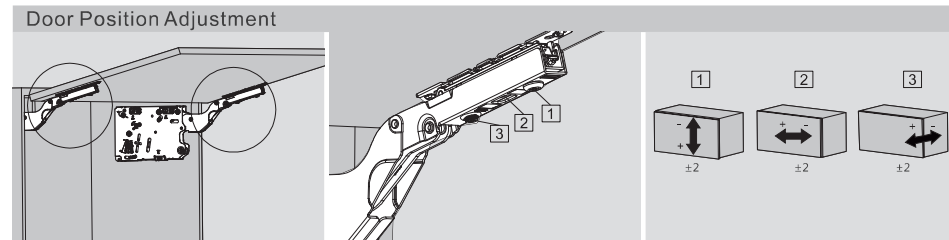

The arm of this device could spring up and cause injury!

Do not push the arm down without door attached

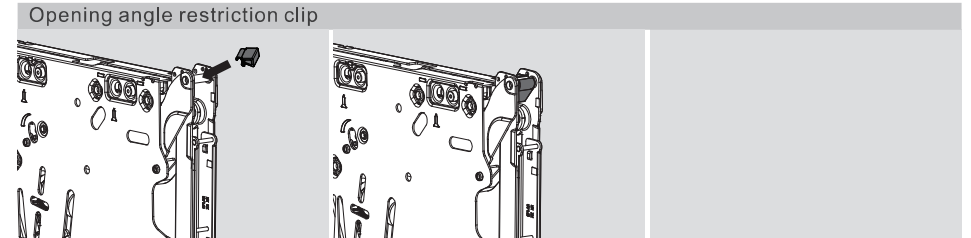

Assembly

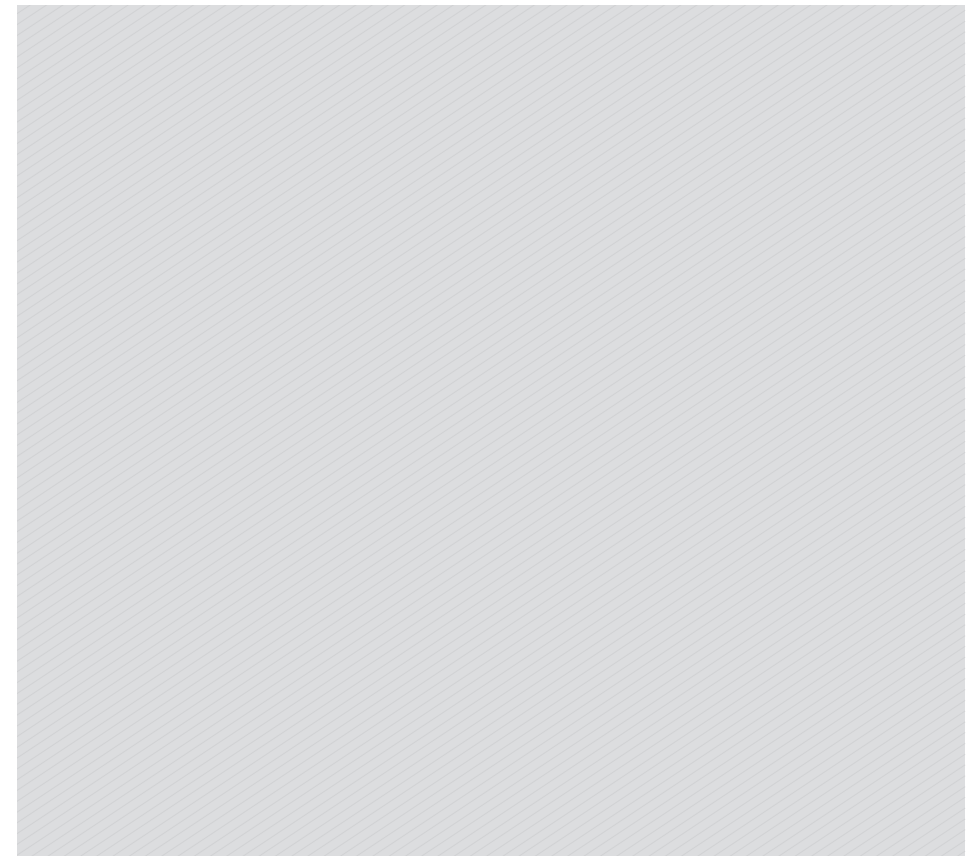

LIFTING
SYSTEM

ST Series

TOP-STAYS



TOP-STAYS

The new experience of the lift-up door

Agile and Unconstrained,
Impressive and Elegant



- Easy to open and stays at any desired position, silent and smooth closing, full access to the inside of the cabinet
- Side, height and depth adjustments - 3D front adjustment of both fronts
- Tool free assembly and removal, easy and fast installation



Quietness



Intelligence



Durability



Eco-Friendliness

TOP-STAYS

ST Series Bi-fold Lifting System

PRODUCT



DESCRIPTION

- Cabinet width up to 1800mm
- Cabinet height:480~1040mm
- 3D front adjustment of both fronts
- Easy to open, and stays at any desired position
- Adjustable soft-closing speed
- Adjustable opening and hovering forces
- Tool free assembly and removal

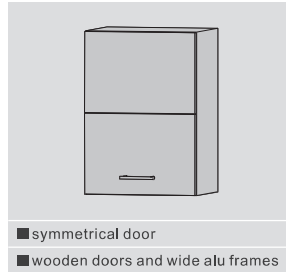

ORDER INFORMATION

1		Lift Mechanism set/ Industrial Package 6 Set/ctn
Cabinet height KH(mm)	Door weight incl handle weight (kg)	Item No.
480-529	5.0-10.0(2.5-5.0 to use 1 lift) 9.6-16.0	ST01AL ST01AM
530-589	4.5-8.9(2.3-4.5 to use 1 lift) 8.7-14.4	ST02AL ST02AM
590-649	4.1-8.1 (2.0-4.1 to use 1 lift) 7.8-13.0	ST03AL ST03AM
650-729	3.7-7.2 (1.8-3.7 to use 1 lift) 7.0-11.6 11.5-19.8	ST04AL ST04AM ST04AH
730-799	6.3-10.6 10.5-18.1(15.7-27.1 to use 3 lift)	ST05AM ST05AH
800-879	5.8-9.6 9.5-16.5(14.2-24.7 to use 3 lift)	ST06AM ST06AH
880-959	5.2-8.8 8.7-15.1(13.0-22.6 to use 3 lift)	ST07AM ST07AH
960-1040	4.8-8.1 8.0-13.9(12.0-20.8 to use 3 lift)	ST08AM ST08AH
6		Centre hinge /Industrial Package Nickel Plated(A01)
Item No.	ST00BG	
Set/ctn	100	
7		Mounting plate for centre hinge/Industrial Package Nickel Plated(A01)
Item No.	T00TQ	
Set/ctn	100	
8		Front Mounting plate /Industrial Package Nickel Plated(A01)
Item No.	ST00YQ	
Set/ctn	200	

2		120° hinge/Industrial Package Nickel Plated(A01)
Item No.	STA685	
Set/ctn	100	
3		Mounting plate for 120° hinge/Industrial Package Nickel Plated(A01)
Item No.	SQ00YQ	
Set/ctn	200	
4		Decoration cover for hinge arm /Industrial Package Nickel Plated(A01)
Item No.	S15H	
Set/ctn	1000	
5		Cover cap set/Industrial Package plastic
Colour	Item No.	Set/ctn
White	STJS02A	20
Grey	STJS02B	20
9		Opening angle restriction clip/Industrial Package Plastic Dark grey (H11)
Opening angle	Item No.	Pcs/ctn
100°	STW100	1000
83°	STW83	1000

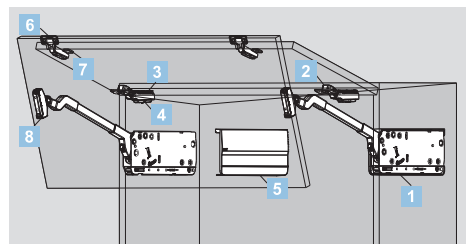

ORDER INFORMATION

T1 Recommended Kit Package

Including:

1x Lift mechanism set	1 X Cover cap set	1 X 120° hinge set	1 X Mounting plate set for 120° hinge	1 X Decoration cover set for hinge arm
1 X Centre hinge set	1X Mounting plate set for centre hinge	1 X Front mounting plate set	20X16mm wooden screws 10X38mm wooden screws	

Please select the corresponding kit package item No. according to cabinet height ,door weight and handle weight

Cabinet height KH(mm)	Door weight incl handle weight (kg)	Kit package item No. (White cap)	Kit package item No. (Grey cap)
480-529	5.0-10.0	ST01AL02A	ST01AL02B
	9.6-16.0	ST01AM02A	ST01AM02B
530-589	4.5-8.9	ST02AL02A	ST02AL02B
	8.7-14.4	ST02AM02A	ST02AM02B
590-649	4.1-8.1	ST03AL02A	ST03AL02B
	7.8-13.0	ST03AM02A	ST03AM02B
650-729	3.7-7.2	ST04AL02A	ST04AL02B
	7.0-11.6	ST04AM02A	ST04AM02B
	11.5-19.8	ST04AH02A	ST04AH02B
	3.2-6.5	ST05AL02A	ST05AL02B
730-799	6.3-10.6	ST05AM02A	ST05AM02B
	10.5-18.1	ST05AH02A	ST05AH02B
800-879	5.8-9.6	ST06AM02A	ST06AM02B
	9.5-16.5	ST06AH02A	ST06AH02B
880-959	5.2-8.8	ST07AM02A	ST07AM02B
	8.7-15.1	ST07AH02A	ST07AH02B
960-1040	4.8-8.1	ST08AM02A	ST08AM02B
	8.0-13.9	ST08AH02A	ST08AH02B

TOP-STAYS

ST Series Bi-fold Lifting System

TOP-STAYS

Assembly, Removal and Adjustment (for ST series Bi-fold Lifting System)

PLANNING

Installation Dimensions(mm)-Symmetrical doors

Peg position and space requirement

Door assembly-wooden doors and wide alu frames

Cornice / crown moulding clearance

Cabinet height KH(mm)	H(mm)	Cabinet height KH(mm)	X(mm)	E.G. Cabinet height KH=600 H=600x0.3-57=123 S=356 (see table below) Gap F=2 X=600-123-356-2=119						
480-589	KHx0.3-28	480-1040	KH-H-S-F	Cabinet height KH(mm)	S(mm)	A(°)	B(mm)	C(mm)	Q(mm)	Y(mm)
590-1040	KHx0.3-57			480-529	301	~115-105	109-156	257-210	278-323	109-76
E.G. Cabinet height KH=500 H=500x0.3-28=122 Cabinet height KH=800 H=800x0.3-57=183				530-589	326	~115-105	123-180	280-223	300-354	121-77
				590-649	356	~115-105	141-194	308-224	327-384	132-84
				650-729	386	~115-102	160-228	335-226	355-428	144-74
				730-799	426	~115-105	181-250	372-293	390-450	162-108
				800-879	461	~115-105	202-280	404-318	422-494	176-115
				880-959	501	~115-105	225-301	440-361	458-529	194-134
				960-1040	541	~115-105	245-335	476-405	493-566	214-148

SFA = Door overlay on the side panel
F = Gap

Installation Dimensions(mm)

Centre hinge

120° Hinge

Drilling distance K(mm)	3	4	5	6
Door overlay D(mm)	15	16	17	18

Number of hinges needed for each door:
Use 3 hinge for cabinet width over 1200mm and door weight over 12kg.
Use 4 hinge for cabinet width over 1800mm and door weight over 12kg.

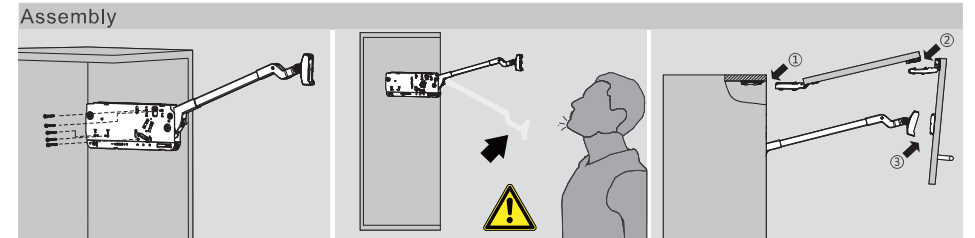

Assembly

The arm of this device could spring up and cause injury. Do not push the arm down without door attached.

Door Assembly

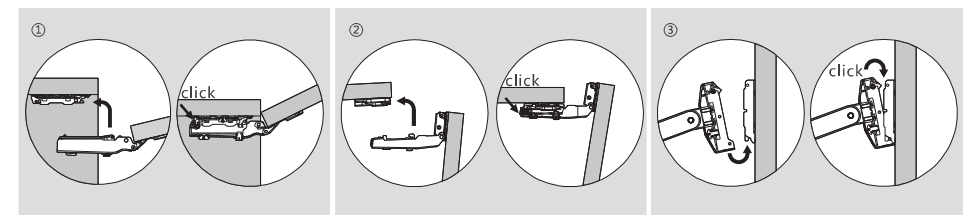

Door Assembly

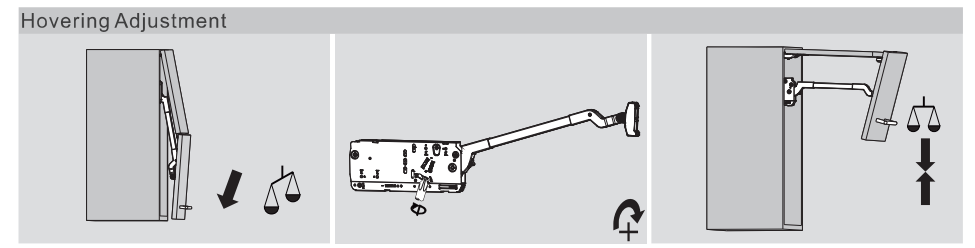
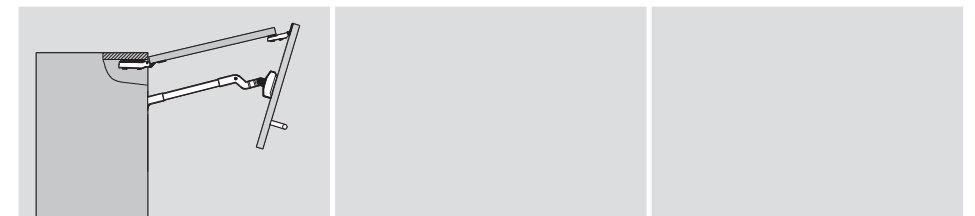

Adjustment

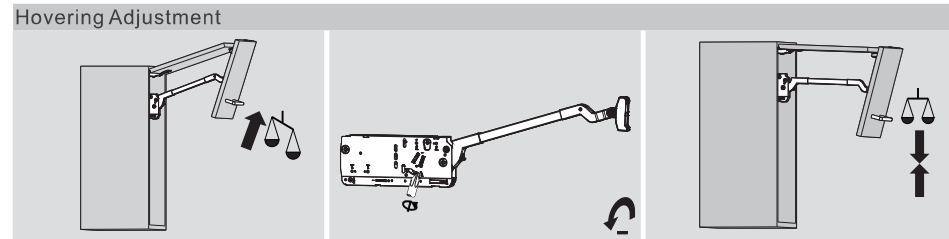

Adjustment

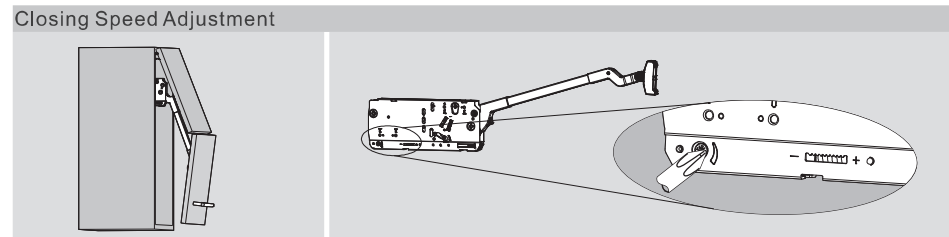

"+" increasing soft-closing time (turn adjustment screw counter-clockwise)
 "-" reducing soft-closing time (turn adjustment screw clockwise)

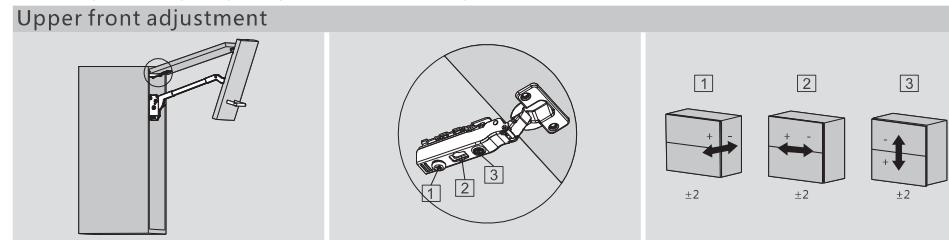

120° hinge

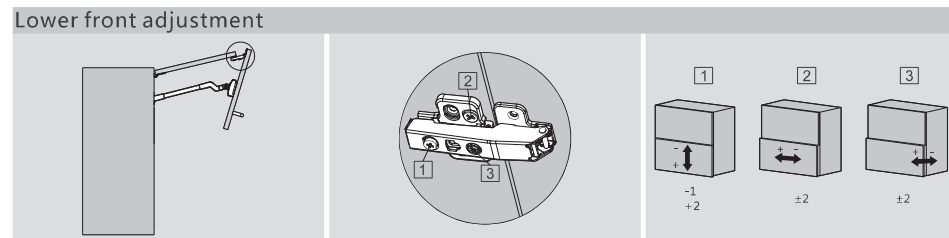

Centre hinge



"+" reducing soft-closing time (turn adjustment screw clockwise)
 "-" increasing soft-closing time (turn adjustment screw counter-clockwise)

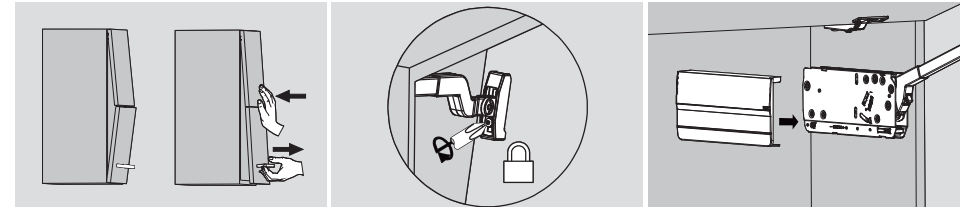

Adjust positions of the doors

Lock screw

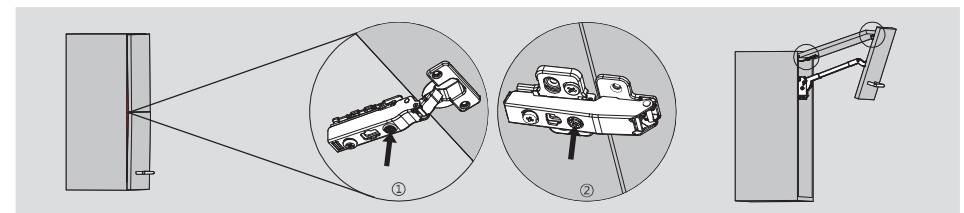

If there is small gap between the doors and the cabinet side; fine-tune the positions of the doors with the adjustment screws

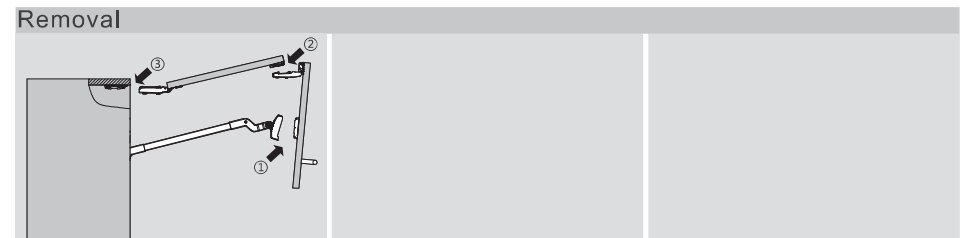

TOP-STAYS

Assembly , Removal and Adjustment(for ST series Bi-fold Lifting System)



Removal

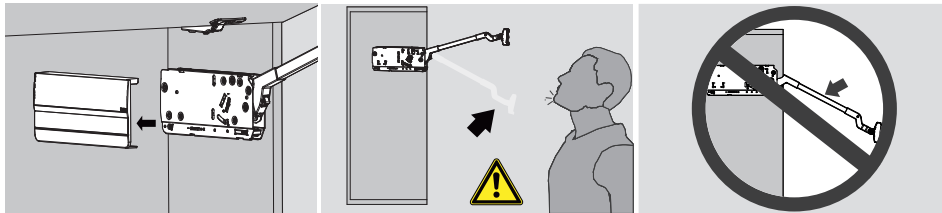
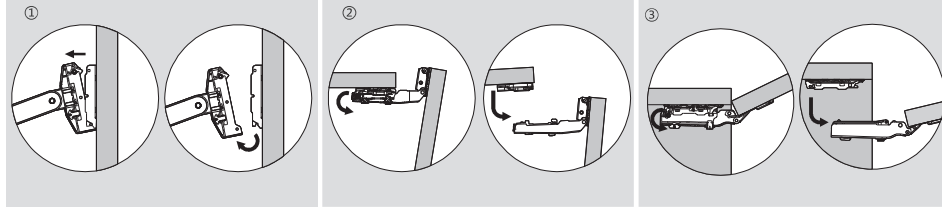

The arm of this device could spring up and cause injury!

Do not push the arm down without door attached

Opening angle restriction clip

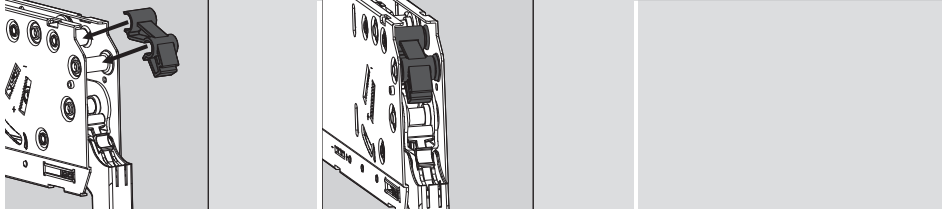

Assembly

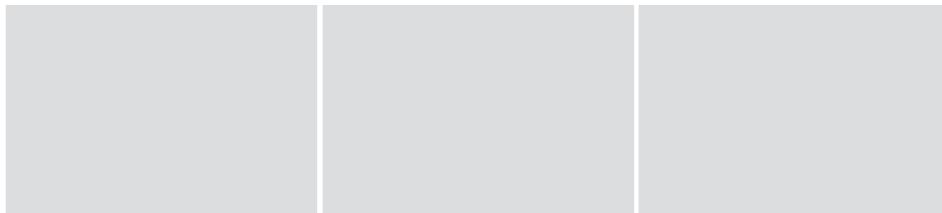

We are continuously developing new products.
For updated product information, please log onto www.dtcctc.com